

Since 1968

COMMAX
SmartHome & Security

User Manual

Doorphone AP-3SG



www.commax.com

COMMAX Co.,Ltd.



- Thank you for purchasing COMMAX products.
- Please carefully read this User's Guide (in particular, precautions for safety) before using a product and follow instructions to use a product exactly.
- The company is not responsible for any safety accidents caused by abnormal operation of the product.



Contents

- 1. Greetings2
- 2. Warnings and caution2
- 3. Part names4
- 4. Features & Functions4
- 5. Contents4
- 6. Installation5
- 7. Wiring5
- 8. Operating6
- 9. Trouble shooting7
- 10. Specification7

























1. Greetings

- * Thank you very much for purchasing of COMMAX products.
- * Please read carefully this user manual and follow its rules.
- * This intercom can be used in offices, and shopping outlets, and provide convenience to use communication on long distances.



2. Warnings and caution

Please follow the things described below in order to prevent any danger or property damage.

 <p>Warning It may cause a serious damage or injury if violated.</p>  <p>Caution It may cause a minor damage or injury if violated.</p>	<table style="width: 100%; border: none;"> <tr> <td style="width: 50%; vertical-align: top; padding: 5px;">  Prohibition.  No disassembly  Shows plugging out the power cord without an exception  Shows the warning and caution for an electric shock.  Shows the warning and caution for a fire. </td> <td style="width: 50%; vertical-align: top; padding: 5px;">  No touch  Must follow strictly. </td> </tr> </table>	 Prohibition.  No disassembly  Shows plugging out the power cord without an exception  Shows the warning and caution for an electric shock.  Shows the warning and caution for a fire.	 No touch  Must follow strictly.
 Prohibition.  No disassembly  Shows plugging out the power cord without an exception  Shows the warning and caution for an electric shock.  Shows the warning and caution for a fire.	 No touch  Must follow strictly.		

⚠ Warning & Caution

Power & Installation

Please don't use several products at the same time on one power socket.

- It may cause a fire due to an abnormal overheating.



Please don't bend the power cable excessively or it may cause an electric shock.

- fire when using a damaged power cable.

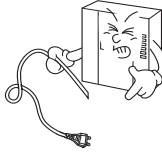

Please don't handle the power cable with a wet hand.

- It may cause an electric shock.

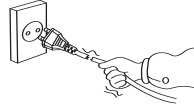

Please plug out the power cable from the socket when not using it for a long period of time.

- It may shorten the product lifespan or cause a fire.

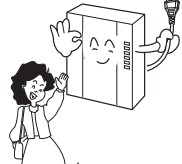

Please don't install the product in the place where there is much oil, smoke or humidity.

- It may cause an electric shock or fire.

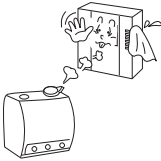

Please don't install the product with the lightning and thunder.

- It may cause an electric shock or fire.

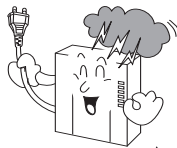

Please don't use and connect this product with other products with different rated voltage.

- It may cause a disorder or fire.

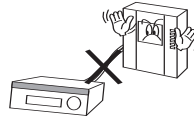

When installing the product that generates heat, please install the product away from the wall (10cm) for the ventilation.

- It may cause a fire due to the increased internal temperature.

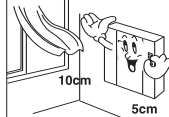

⚠ Warning & Caution

Cleaning & Use

Please don't disassemble, repair or rebuild this product arbitrarily (please contact the service center if a repair is needed).

- It may cause an electric shock or fire.



If an abnormal sound, burning smell or smoke is coming out of the product, please plug out the power cable and contact a service center.

- It may cause an electric shock or fire.

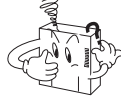

Please don't insert any metallic or burnable materials into the ventilation hole.

- It may cause an electric shock or fire.

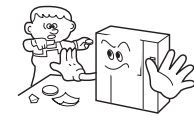

When cleaning the product, please rub it with a soft and dry cloth after plugging out the power cable. (Please don't use any chemical products such as wax, benzene, alcohol or cleanser.)





3. Part names

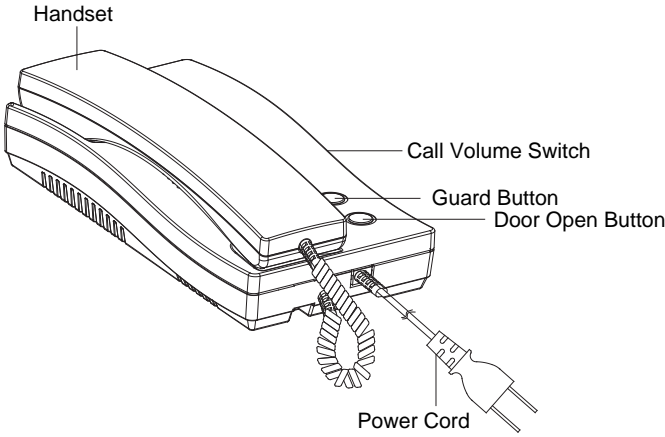

4. Functions

- * Calling to Guard unit and talking
- * Door release (Interlocking with Door phone)
- * Talking to Common lobby and Individual front door



5. Contents

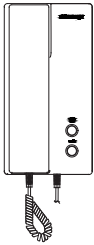

AP-3SG

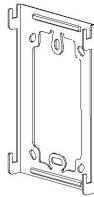

Mounting bracket

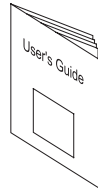

User's guide



PH2T 3 X 6 ZnY



HAND SET

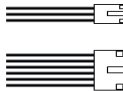

Connector
(3P X 1 , 6P X 1)



T4 x 18
Mounting screw



BINDING



6. Installation

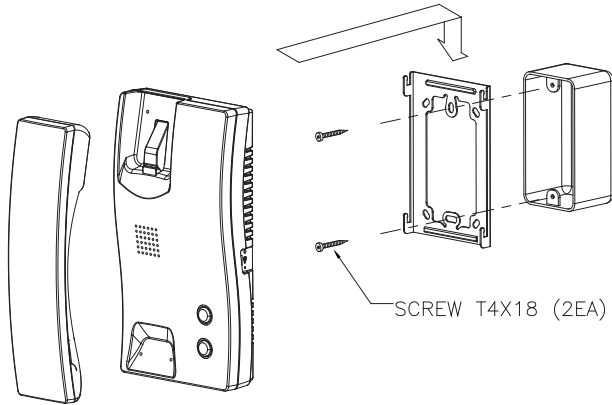

* Caution for Monitor

When to install it, avoid the place where can be influenced by Magnetism, Humidity, Direct light and heater.



7. Wiring

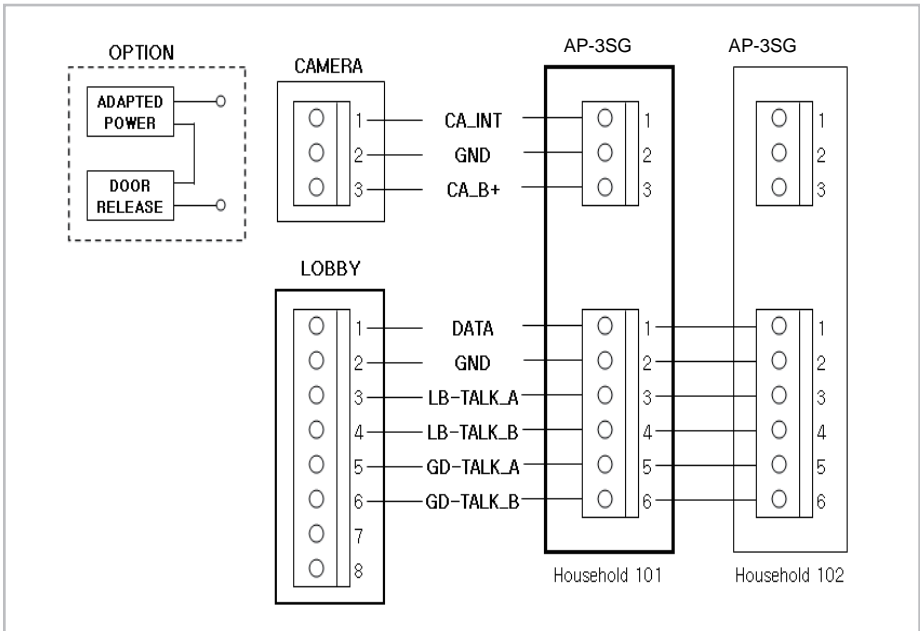



8. Operating

1) Calling of Visitor

- ① When a visitor presses call button, with Calling sound from the speaker is emitted.
- ② For Visitors, please talk with the handset (Currency time 60 second)
- ③ When lay the handset after the end of taking with a visitor, everything is done. When a visitor is allowed to be in, the door is released with the sound, if a user presses the door open button,
(In case of using the camera which is interlocked with Door released function)
- ④ If guard or lobby calls during the conversation between house and individual entrance, phone rings. If you hang up the phone and pick it up again at this time, it will switch the phone over to guard or lobby. (Previous call is ended)
Caution : Do not hold the handset at your ear when you press hook switch to switch call.

2) Calling with Common lobby

- ① Calling sound from the speaker is emitted when a visitor calls from Common lobby.
Pick the handset to talk this time
- ② The sound of Door station is emitted while talking over the phone with the Common lobby.
- ③ If you hang up the phone and pick it up again, the conversation with Lobby will be disconnected, and the conversation with individual entrance will be available. If the door release button is pressed while talking over the phone with Common lobby, the door is released with sound and the talk is ended.
Caution: Do not hold the handset at your ear when you press hook switch to switch call.

3) Calling with Guard station

- ① Pick up the handset which is connected with a Guard station.
and if a user presses the Guard button, the sound will be emitted from Guard station.
The talk between Guard and monitor is available this time.
- ② The calling sound is emitted from the handset if the Call button is pressed while talking over the phone with Guard station, and it is automatically shut down after 30 minutes by showing the screen of outside status
Caution : Do not hold the handset at your ear when you press hook switch to switch call.
- ③ If the call button is pressed from Guard station while talking over the phone with the Door station, the Signal sound is emitted to the handset. And the talk with Guard station is available if a user lays and picks the handset of the monitor or press the Guard button.
Caution : Do not hold the handset at your ear when you press hook switch to switch call.
- ④ When a guardian would like to talk with a household, the calling sound is emitted from the Monitor if the guardian presses the call button. And if a users picks up the handset, the talk is available with a Guardian

9. Trouble shooting.

If you think that the product has trouble, please first check below contents before you ask a repair.

Troubles	Check Point	Actions
<ul style="list-style-type: none"> The power supply is not on. All works are stopped 	<ol style="list-style-type: none"> The power supply cord is missing or not. The power supply switch (down) is off or not. 	<ol style="list-style-type: none"> Please connect the power supply cord Please turn on the power switch pushing the left (down) to the right(up).
<ul style="list-style-type: none"> A Call operation is not performed. (Door, Interphone function) 	<ol style="list-style-type: none"> The wiring between other units is connected correctly in good order or not. The wiring is missing or not. 	<ol style="list-style-type: none"> Please refer to connection related page and manage. Please connect correctly to the terminal.
<ul style="list-style-type: none"> The product does not produce the sound. (Call volume, Talk volume) 	<ol style="list-style-type: none"> A sound volume lies in minimum or not. 	<ol style="list-style-type: none"> Please adjust the sound volume switch properly turing the left(down) to the right(up), as you want.

10. Specifications

Contents	Description (AP-3SG)
Wiring	Common Lobby : 6 wires, Door camera : 3 wires
Rated Voltage	220-230V~, 50/60Hz
Power consumption	Stan-by mode : 3W Operating : (Max.) 4W
Distance	Door : 50m/ ϕ 0.65, Common lobby : 300m (UTP)
Temperature	0°C ~ +40°C
Dimension	107(W) X 195(H) X 38(D) mm
Weight	600g

COMMAX

COMMAX Co.,Ltd.

513-11, Sangdaewon-dong, Jungwon-gu, Seongnam-si, Gyeonggi-do, Korea

Int'l Business Dept. Tel. : +82-31-7393-540~550 Fax. : +82-31-745-2133

Web site : www.commax.com

Printed In Korea / 2011.11.104